

FOR STRAIGHT AND  
CURVED STAIRCASES



[www.ovitelevator.com](http://www.ovitelevator.com) [info@ovitasansor.com](mailto:info@ovitasansor.com)  
+ 90 216 452 10 70 444 OViT (6848)

The award-winning starlift can be truly considered one of the world's leading stairlifts. The is fitted onto your stair case and not your wall allowing the lift to be installed quickly, easily and with minimal disruption to your home.

**THE SINGLE RAIL  
STAIRLIFT IS THE  
MARKET LEADER  
WHEN IT COMES TO  
CURVED STAIRLIFTS  
AND IS THE SMARTEST  
LIFT OF ITS TYPE.**

02

O

V

i

T

E l e v a t o r & E s c a l a t o r



[www.ovitelevator.com](http://www.ovitelevator.com) [info@ovitasansor.com](mailto:info@ovitasansor.com)  
+ 90 216 452 10 70 444 OVIT (6848)





“

I'm really pleased and very happy with the style of my stairlift. I'm over the moon that I don't have to walk up and down the stairs anymore, I'm over the moon with the whole thing.



06

# ADVANCED SWIVEL AND LEVELLING TECHNOLOGY

OVIT technology enables the stairlift to rotate and stay perfectly level while in motion. By rotating during travel, you're always in the safest and most comfortable position.





1

The seat is always in the correct position to The swivels as it travels, this means that getting on and end of the staircase is quick and easy. At the top of the staircase the seat can rotate away from the open staircase, allowing a safe exit from the seat.geton and off safely off the lift at either

2

Constantly working to save you time and provide safety and comfort

Technology operates while the lift is moving. Therefore you avoid additional stops and swivel movements at the beginning, during and at the end of the ride. This saves time and provides additional safety and moves in one. Comfort. The lift really

3

Internal or external rail on the narrowest and steepest stairs

Even in cases where the staircase is narrow and steep, the Flow2 can be installed closer to the step and on either side of the staircase. Your stair-lift will be less obtrusive and your staircase remains accessible for other family members in your home.

4

Unique technology that can only be found with the

Your well-being is important to us – when you choose technology the footrest swivels with the seat ensuring your legs and feet remain in a natural and comfortable position, relieving any additional strain on your joints.



**TECHNOLOGY ALLOWS THE RAIL  
TO BE KEPT AS LOW AS 62MM  
ON A WIDE VARIETY OF STAIR-  
CASE STYLES AND CONFIGURA-  
TIONS.**

09

# OPTIONSIT'S ALL ABOUT YOU

You ensure the best fit for your staircase.  
When you choose the stairlift, can be  
tailor-made to fit any staircase. With a  
single discreet rail, this stairlift

10

OVIT

Elevator & Escalator



[www.ovitelevator.com](http://www.ovitelevator.com) [info@ovitasansor.com](mailto:info@ovitasansor.com)  
+ 90 216 452 10 70 444 OVIT (6848)



# RAiL



**Standard Drop Nose** The standard drop nose is the perfect solution if there is an obstruction such as a door near to the bottom of the stairs. The drop nose requires just 175 mm of space from the bottom step.



**Vertical 'Short-Start' Drop Nose** Where space is even tighter at the bottom the 'short-start' drop nose can be installed, needing only 100 mm of space from the bottom step.



**Horizontal Overrun** Where you have extra space at the bottom of the stairs the horizontal overrun allows the chair to be parked away from the bottom step.



**Parking Curve** A parking curve allows the chair to be parked neatly out of the way of the stairs.

11

# COLOUR



Grey



White/Grey



Beige/Brown

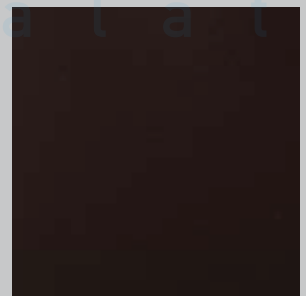

Brown/Grey

# UPHOLSTERY

## Vinyl



Red

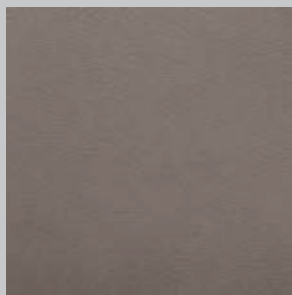

Grey



Maroon

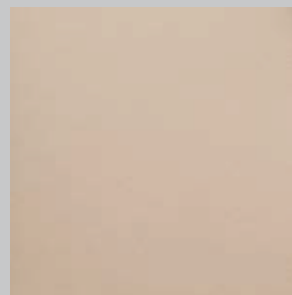

Sisal

## Fabric

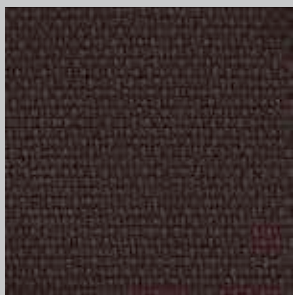

Dark Brown



Beige



Red

12

## Elegant Leather

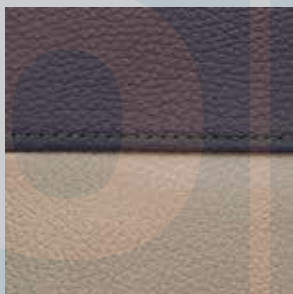

Aubergine-Beige

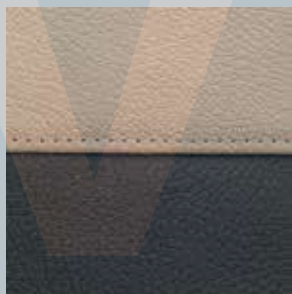

Beige-Grey



Brown-Beige



Brown-Cognac



Brown-Grey



Red-Beige

## Deluxe Leather



Beige

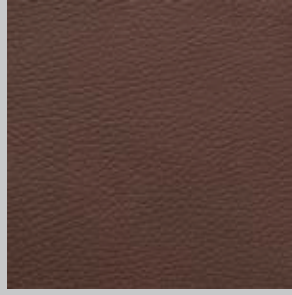

Dark Brown



Dark Red

## AR MREST



Straight



Curved

## JOYSTICK & CALL DEVICE



Joystick



Call Device



# CALL & PARK YOU'RE iN CONTROL

14

Remote control units at the top and bottom of the stairs are used to call your when not in use.lift and to send it to a parking point





16



**THE FLOW2 STAIRLIFT  
CAN BE INSTALLED ON  
STAIRCASES AS  
NARROW AS 610MM  
AND AS STEEP AS 70°.**



17

Elevator & Escalator

[www.ovitelevator.com](http://www.ovitelevator.com) [info@ovitasansor.com](mailto:info@ovitasansor.com)  
+ 90 216 452 10 70 444 OViT (6848)



# TECHNICAL SPECIFICATION CERTIFIED TO THE HIGHEST STANDARDS

18

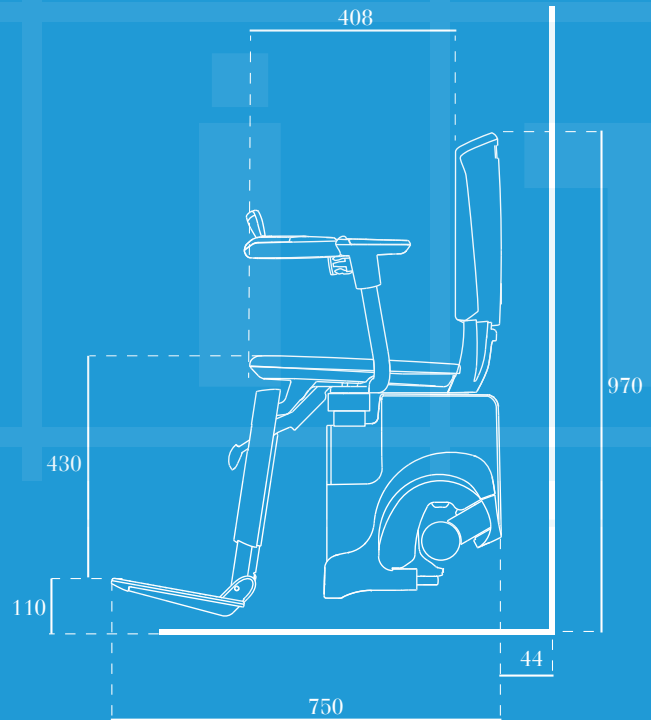
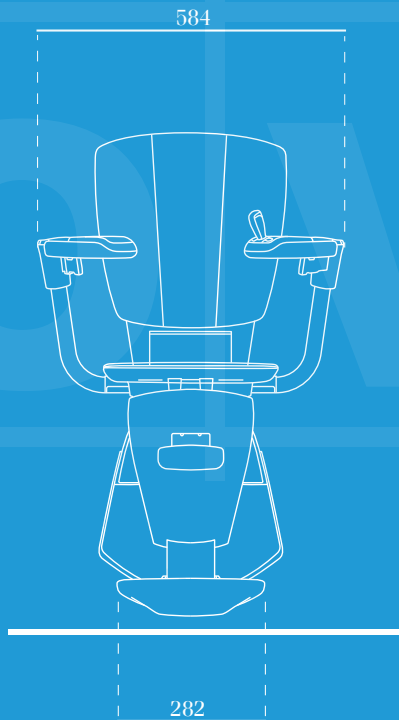

## SPECIFICATION

Speed	Max 0.15 m/s
Drive Type	Rack and pinion
Motor Wattage	350 W – Drive Motor 350 W – Horizontal Motor
Weight Capacity	125 kg
Batteries	2 × 12 V batteries; total 24V
Operation	Joystick control as standard
Staircase Incline	Up to 70°
Certification	Machine Directive 2006/42/EG BS EN 81-40
Automatic Stop	Yes
Footrest	Yes
Retractable Safety Belt	Yes

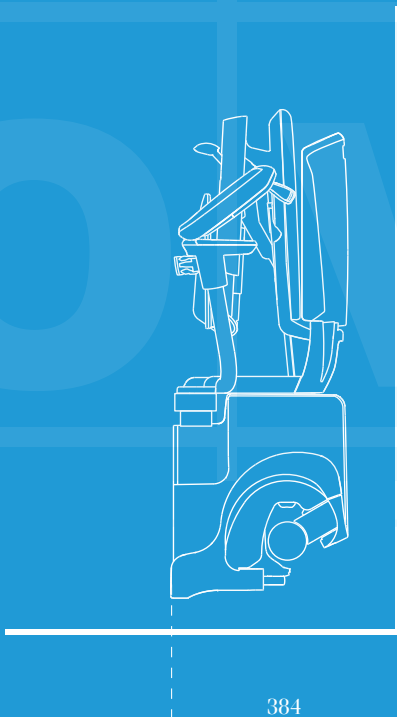

“

reliable products I've had the pleasure of working with.”

19





Elevador & Escalator

YOUR STAIRCASE REMAINS  
OPEN AND ACCESSIBLE FOR  
OTHER FAMILY MEMBERS IN  
YOUR HOME.



21

Elevator & Escalator

[www.ovitelevator.com](http://www.ovitelevator.com) [info@ovitasansor.com](mailto:info@ovitasansor.com)  
+ 90 216 452 10 70 444 OViT (6848)



# ABOUT

Access is a division of OViT ELEVATOR Ltd. We give people around the world the ability to move comfortably distribute via a network of carefully chosen business partners. When you choosing a high-quality product, supported by expert service and advice. around buildigs by providing stairlifts, platform lifts and home lifts, which wechoose an lift, you're

Our partners are all specialists in mobility or elevator products, and they receive extensive technical and commercial training on our products. Your partner will guide you through the product options to help you and suits your surroundings. You'll also receive expert advice to ensure that your and safety regulations. choose a lift that meets your own needs new lift conforms to relevant accessibility

Our products are designed for easy installation and maintenance, with everything taken care of by your approved partner.

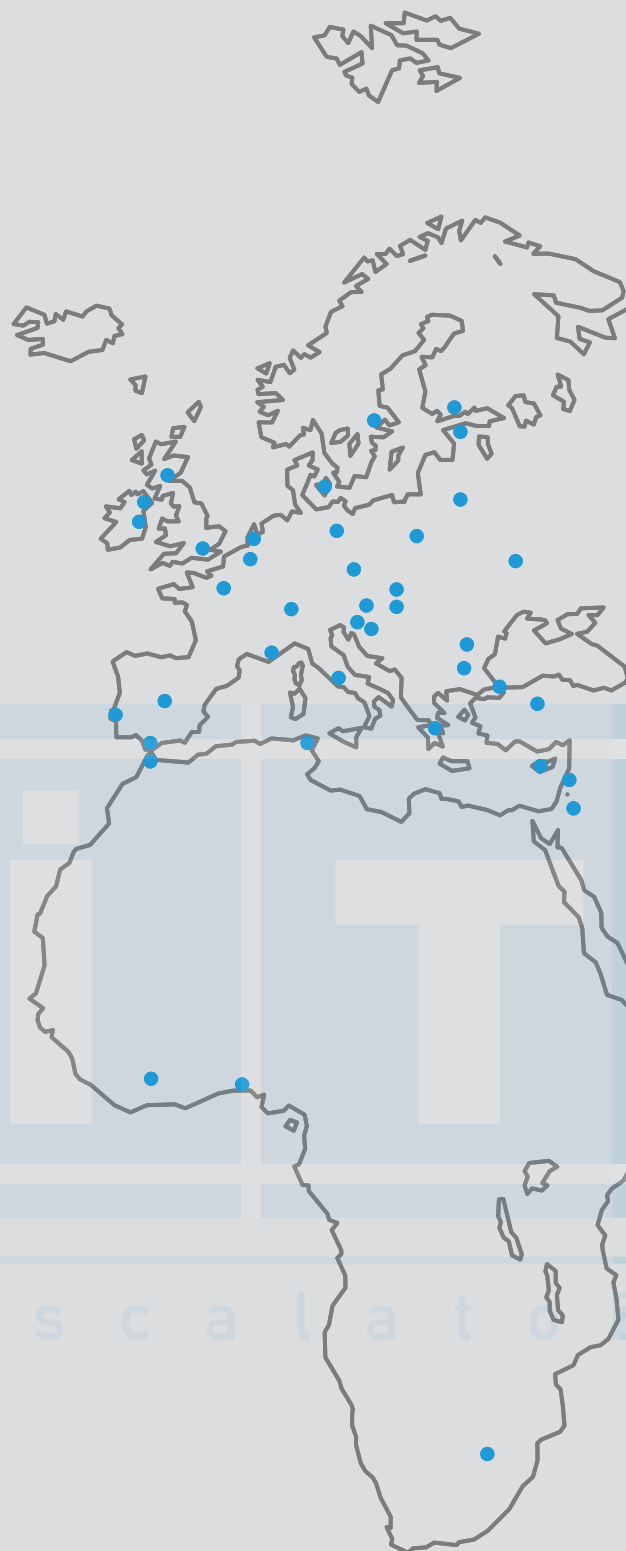





SINCE 1976 WE'VE BEEN  
SIMPLIFYING COMPLEX  
CHOICES TO HELP PEOPLE  
MOVE AROUND THEIR  
HOMES.



www.ovitelevator.com info@ovitasensor.com  
+ 90 216 452 10 70 444 OViT (6848)



Your local dealer is:



Is one of Europe's leading suppliers of  
stairlifts, platform lifts and home lift  
solutions.

